

# Pressure switches for air DL..H, DL..N

## OPERATING INSTRUCTIONS

Cert. Version 11.17 · Edition 05.22 · EN · 03251434

### 1 SAFETY

#### 1.1 Please read and keep in a safe place



Please read through these instructions carefully before installing or operating. Following the installation, pass the instructions on to the operator. This unit must be installed and commissioned in accordance with the regulations and standards in force. These instructions can also be found at [www.docuthek.com](http://www.docuthek.com).

#### 1.2 Explanation of symbols

**1, 2, 3, a, b, c** = Action

→ = Instruction

#### 1.3 Liability

We will not be held liable for damage resulting from non-observance of the instructions and non-compliant use.

#### 1.4 Safety instructions

Information that is relevant for safety is indicated in the instructions as follows:

#### **DANGER**

Indicates potentially fatal situations.

#### **WARNING**

Indicates possible danger to life and limb.

#### **CAUTION**

Indicates possible material damage.

All interventions may only be carried out by qualified gas technicians. Electrical interventions may only be carried out by qualified electricians.

#### 1.5 Conversion, spare parts

All technical changes are prohibited. Only use OEM spare parts.



### CONTENTS

1 Safety	1
2 Checking the usage	2
3 Installation	2
4 Wiring	4
5 Adjustment	4
6 Function check	5
7 Accessories	5
8 Technical data	6
9 Designed lifetime	7
10 Certification	7
11 Logistics	8
12 Disposal	8

## 2 CHECKING THE USAGE

### DL..H, DL..N

For monitoring rising and falling air or flue gas pressure. DG..H switches and locks off with rising pressure, DG..N switches and locks off with falling pressure.

They can be unlocked using the manual reset.

This function is only guaranteed when used within the specified limits – see page 6 (8 Technical data). Any other use is considered as non-compliant.

### 2.1 Type code

<b>DL</b>	Pressure switch for air
<b>10</b>	Adjusting range 1.0–10 mbar
<b>50</b>	Adjusting range 2.5–50 mbar
<b>150</b>	Adjusting range 30–150 mbar
<b>A</b>	Rp 1/4 connection, tube connection, hand wheel
<b>K</b>	With tube connection, hand wheel
<b>H</b>	Switches and locks off with rising pressure
<b>N</b>	Switches and locks off with falling pressure
<b>G</b>	With gold contacts
<b>-3</b>	Electrical connection via screw terminals, IP 54
<b>-4</b>	Electrical connection via screw terminals, IP 65
<b>-5</b>	Electrical connection via 4-pin plug, without socket, IP 54
<b>-6</b>	Electrical connection via 4-pin plug, with socket, IP 54
<b>-9</b>	Electrical connection via 4-pin plug, with socket, IP 65
<b>K2</b>	Red/green pilot LED for 24 V DC/AC
<b>T</b>	Blue pilot lamp for 230 V AC
<b>T2</b>	Red/green pilot LED for 110 to 230 V AC
<b>N</b>	Blue pilot lamp for 120 V AC
<b>1</b>	With 1 test key
<b>2</b>	With 2 test keys
<b>A</b>	External adjustment

### 2.2 Part designations

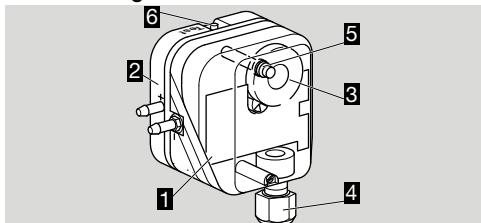

- 1 Upper housing section with cover
- 2 Lower housing section
- 3 Hand wheel
- 4 M16 cable gland
- 5 Manual reset
- 6 Test key (DL..A)

## 2.3 Type label

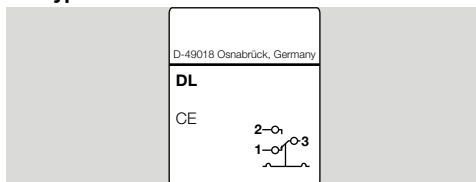

Max. inlet pressure = withstand pressure, mains voltage, ambient temperature, enclosure: see type label.

## 3 INSTALLATION

### ⚠ CAUTION

Please observe the following to ensure that the unit is not damaged during installation:

- Dropping the device can cause permanent damage. In this event, replace the entire device and associated modules before use.
  - Check max. ambient temperature, see page 6 (8 Technical data).
  - Vapours containing silicone can adversely affect the functioning of electrical contacts. When using silicone tubes, only use silicone tubes which have been sufficiently cured.
  - Condensation must not be allowed to get into the housing. If possible, install pipework with an ascending gradient. Otherwise, there is a risk of icing of condensation at subzero temperatures, the switching point shifting or corrosion in the device which can lead to malfunctions.
  - Ozone concentrations exceeding 200 µg/m<sup>3</sup> accelerate the ageing of elastomer materials and reduce the service life. When installing outdoors, place the pressure switch in a roofed area and protect from direct sunlight (even IP 65 version).
  - Avoid strong impact on the unit.
  - In case of highly fluctuating pressures, install a restrictor orifice.
- Ensure that there is sufficient installation space.
- Ensure unobstructed view of the hand wheel.

### 3.1 Installation position

Installation in the vertical or horizontal position, or sometimes upside down, preferably with vertical diaphragm. If installed in a vertical position, the switching point  $p_S$  will correspond to the scale value SK set on the hand wheel. If installed in another position, the switching point  $p_S$  will change and no longer correspond to the set scale value SK. Switching point  $p_S$  must be checked.

$p_S = SK$	SK + 0,18 mbar [+ 0,071 "WC]	SK - 0,18 mbar [- 0,071 "WC]
DL 10 - 150AH, ..AN, ..KH, ..KN		

### 3.2 Installing the pressure switch

The following screw specifications apply when using a (1 mm thick) mounting plate and self-tapping screws for plastic:

	Hole dia./depth	Screw dia./length
DL..A..	Ø 2.7 x 8 mm	Ø 3.5 x 8 mm
DL..A..	Ø 3.5 x 8 mm	Ø 4 x 8 mm
DL 5-150K	Ø 3 x 16 mm	Ø 3.5 x 16 mm

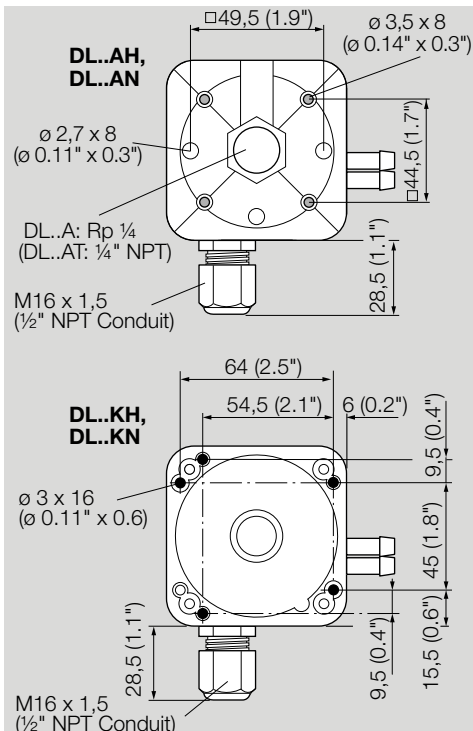

### 3.3 Connecting the pressure line

→ DL..A: upon delivery, port 2 is closed off by a rubber cap.

#### DL..A

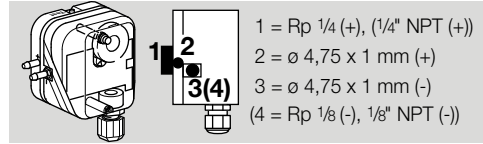

→ Positive pressure, port 1 or 2.

→ Negative pressure, port 3; after unscrewing port 3, also port 4.

#### DL..K

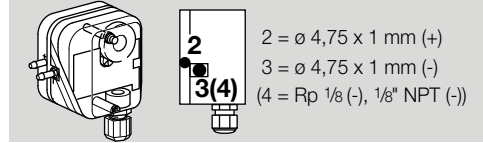

→ Positive pressure, port 2.

→ Negative pressure, port 3; after unscrewing port 3, also port 4.

#### Positive pressure measurement

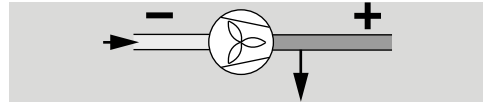

→ 1 or 2 = positive pressure port (+).

→ If port 2 is used, close off port 1.

→ 3 or 4 = remains open to ventilate the upper diaphragm chamber.

#### Negative pressure measurement

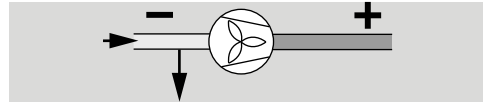

→ 3 or 4 = negative pressure port (-).

→ 1 or 2 = remains open to ventilate the upper diaphragm chamber.

#### Differential pressure measurement

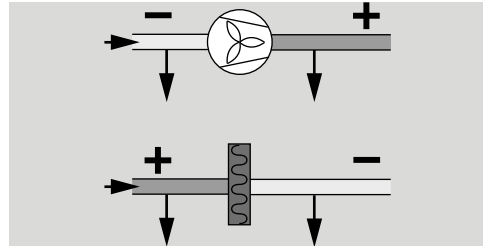

→ 1 or 2 = port for the higher positive pressure or lower negative pressure (+).

→ 3 or 4 = port for the lower positive pressure or higher negative pressure (-).

#### Finalizing the installation

→ Seal the ports that are not in use.

## 4 WIRING

Pressure switch DL..H, DL..N can be used in Zone 1 (21) and 2 (22) hazardous areas if an isolating amplifier is installed upstream in the safe area as "Ex-i" apparatus pursuant to EN 60079-11 (VDE 0170-7):2012.

DL..H, DL..N as "simple electrical apparatus" pursuant to EN 60079-11:2012 corresponds to the Temperature class T6, Group II. The internal inductance/capacitance is  $L_i = 0.2 \mu\text{H}/C_i = 8 \text{ pF}$ .

→ If the pressure switch has switched a voltage  $> 24 \text{ V}$  ( $> 30 \text{ V}$ ) and a current  $> 0.1 \text{ A}$  at  $\cos \varphi = 1$  or  $> 0.05 \text{ A}$  at  $\cos \varphi = 0.6$  once, the gold plating on the contacts will have been burnt through. It can then only be operated at this power rating or higher power rating.

### CAUTION

– To ensure that the DL..H, DL..N is not damaged during operation, note the switching capacity, see page 6 (8 Technical data).

In the case of low switching capacities, such as 24 V, 8 mA, for example, we recommend using an RC module (22  $\Omega$ , 1  $\mu\text{F}$ ) in air containing silicone oil.

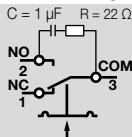

1 Disconnect the system from the electrical power supply.

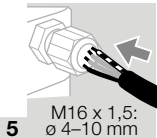
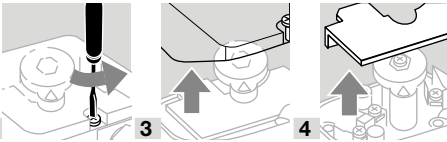

2 Wire as shown on the connection diagram.  
3 Tighten the M16 gland (1/2" NPT conduit).

→ Contacts 3 and 2 close when subject to increasing pressure. Contacts 1 and 3 close when subject to falling pressure. With the NO contact, the NC contact is omitted.

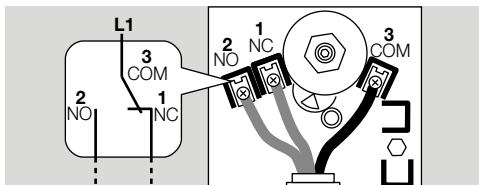

## 5 ADJUSTMENT

→ The switching point is adjustable via hand wheel.

- 1 Disconnect the system from the electrical power supply.
  - 2 Unscrew the housing cover.
- Once the settings have been adjusted successfully, fit the housing cover again. Note the tightening torques, see page 6 (8 Technical data).
- 3 Connect an ohmmeter.

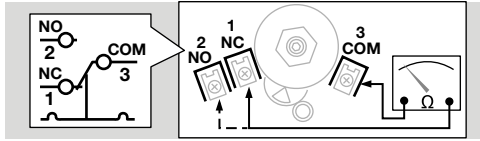

- 4 Set the switching point using the hand wheel.
- 5 Connect a pressure gauge.

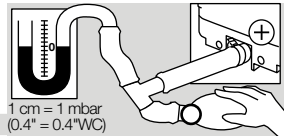

- 6 Apply pressure. In doing so, monitor the switching point on the ohmmeter and the pressure gauge.
- 8 If the DL..H, DL..N does not trip at the desired switching point, correct the adjusting range using the hand wheel. Relieve the pressure and repeat the process.

### 5.1 Adjusting range

Type	Adjusting range <sup>1)</sup> [mbar]	Max. inlet pressure <sup>2)</sup> [mbar]	Reset pressure <sup>3)</sup> [mbar]
DL 10..H, DL 10..N	1–10	300	0.4–1
DL 50..H, DL 50..N	2.5–50	300	1–2
DL 150..H, DL 150..N	30–150	300	2–5

Type	Adjusting range <sup>1)</sup> [°WC]	Max. inlet pressure <sup>2)</sup> [°WC]	Reset pressure <sup>3)</sup> [°WC]
DL 10..H, DL 10..N	0.4–4	117	0.16–0.4
DL 50..H, DL 50..N	1–20	117	0.4–0.8
DL 150..H, DL 150..N	12–60	117	0.8–2

1) Adjusting tolerance =  $\pm 15\%$  of the scale value.

2) Max. inlet pressure = withstand pressure.

3) Difference between switching pressure and possible reset.

Deviation from the switching point during testing pursuant to EN 1854 Air pressure switches:  $\pm 15\%$ .

## 6 FUNCTION CHECK

We recommend a function check once a year.  
DL..A

- 1 Press the test key during operation – the pressure switch switches.

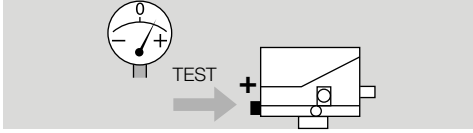

- 2 In case of differential pressure, press both keys simultaneously.

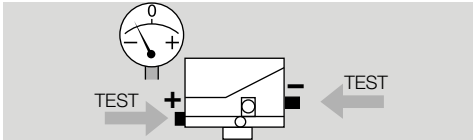

## 7 ACCESSORIES

### 7.1 Restrictor orifice

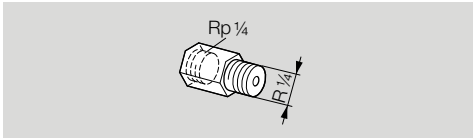

For CE certified pressure switches.

In the case of high pressure fluctuations, we recommend using a restrictor orifice (contains non-ferrous metals).

Hole diameter 0.2 mm, Order No.: 75456321

Hole diameter 0.3 mm, Order No.: 75441317

### 7.2 Z-angle bracket

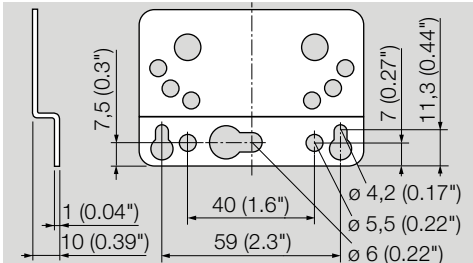

For DL..K: Order No. 74916158.

For DL..A: Order No. 74913661.

### 7.3 Fastening set with screws, U-shape bracket

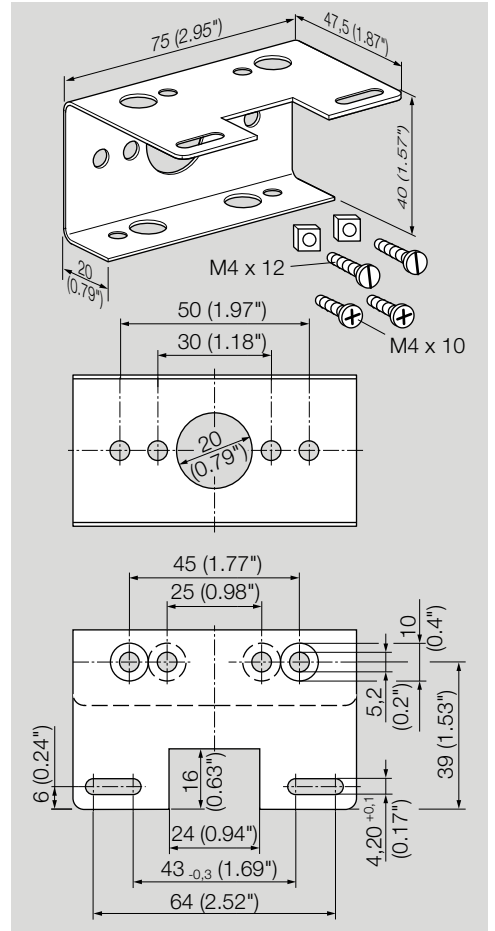

Order No.: 74915387

### 7.4 Standard coupler plug set

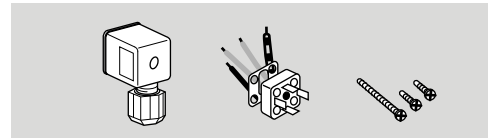

For DL..A, DL..K: Order No. 74916159.

## 7.5 Pilot lamp, red/blue

Pilot lamp, red

110/120 V AC, I = 1.2 mA, Order No.: 74920430.

230 V AC, I = 0.6 mA, Order No.: 74920429.

Pilot lamp, blue

110/120 V AC, I = 1.2 mA, Order No.: 74916121.

230 V AC, I = 0.6 mA, Order No.: 74916122.

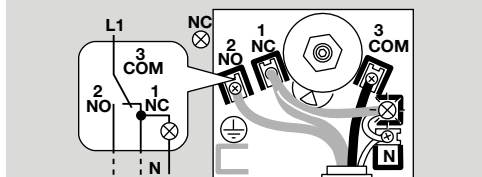
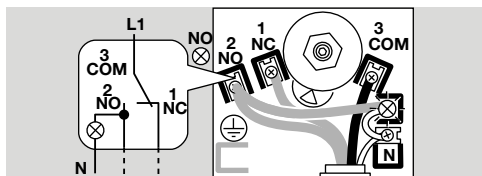
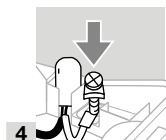
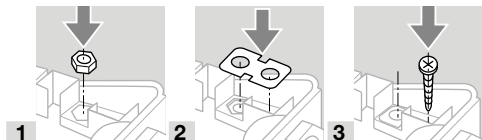
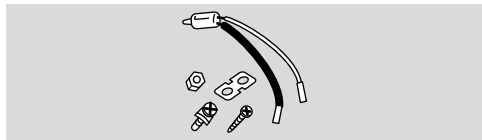

## 7.6 Red/green LED for 24 V DC/AC or 110–230 V AC

24 V DC, I = 16 mA; 24 V AC, I = 8 mA, Order No.: 74921089.

110 to 230 V AC, Order No.: 74923275.

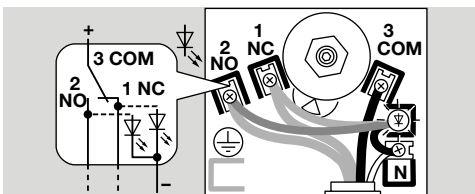
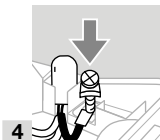
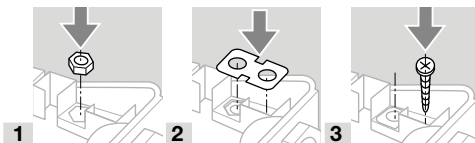
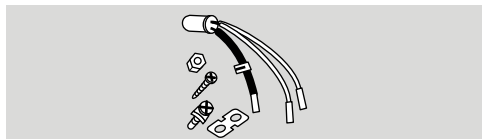

## 7.7 Tube set

To be used with air only.

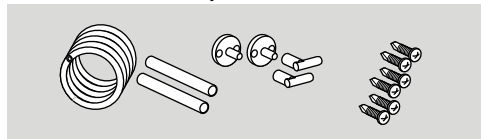

With 2 m PVC tube, 2 duct connection flanges with screws, 2 x 90 mm extensions, 2 angle connectors for DL.

Order No.: 74919272.

## 8 TECHNICAL DATA

### 8.1 Ambient conditions

Enclosure to IEC 60529: IP 54, IP 65.

Permitted ambient temperature in operation:

-15 to +60°C (5 to 140°F).

Storage and transport temperatures:

-20 to +40°C (-4 to +104°F).

Micro switch to EN 61058-1.

Gas types: air or flue gas, no flammable gases, no aggressive gases.

Icing, condensation and dew in and on the unit are not permitted.

Safety class II to VDE 0106-1.

This unit is not suitable for cleaning with a high-pressure cleaner and/or cleaning products.

#### 8.1.1 Pressure switch with NBR diaphragm

Long-term use in the upper ambient temperature range accelerates the ageing of the elastomer materials and reduces the service life (please contact manufacturer). Continuous operation with gases containing more than 0.1 %-by-vol. H<sub>2</sub>S or ozone concentrations exceeding 200 µg/m<sup>3</sup> accelerate the ageing of elastomer materials and reduce the service life.

## 8.2 Mechanical data

Medium temperature = ambient temperature.  
Max. inlet pressure  $p_{max}$  = withstand pressure, switching differential, see page 4 (5 Adjustment).  
Diaphragm pressure switch, NBR, silicone-free.  
Housing: glass fibre reinforced PBT plastic with low gas release.  
Weight: DL..A: 200 g (7,1 oz), DL..K: 190 g (6,7 oz)  
Recommended tightening torque:

Component	Tightening torque [Ncm]
Cover screws	65
M16 x 1.5 cable gland	50
Clamping terminal screws	80
Rp 1/8 connection on upper housing section	250
Rp 1/4 (1/4" NPT) connection on lower housing section	600

## 8.3 Electrical data

Line entrance: M16 x 1.5 (1/2" NPT conduit), clamping range: diameters of 4 to 10 mm.  
Type of connection: screw terminals, cable diameter: 0.5 to 1.8 mm (AWG 24 to AWG 13).

### 8.3.1 Switching capacity

	U	I ( $\cos \phi = 1$ )	I ( $\cos \phi = 0.6$ )
DL	24–250 V AC	0.05–5 A	0.05–1 A
DL..G	5–250 V AC	0.01–5 A	0.01–1 A
DL..G	5–48 V DC	0.01–1 A	0.01–1 A
DL..T	30–240 V AC	5 A	0.5 A
DL..TG	< 30 V AC/ DC	0.1 A	0.05 A

Contact gap < 3 mm ( $\mu$ ).

If the pressure switch has switched a voltage > 24 V (> 30 V) and a current > 0.1 A at  $\cos \phi = 1$  or > 0.05 A at  $\cos \phi = 0.6$  once, the gold plating on the contacts will have been burnt through. It can then only be operated at this power rating or higher power rating.

## 9 DESIGNED LIFETIME

This information on the designed lifetime is based on using the product in accordance with these operating instructions. Once the designed lifetime has been reached, safety-relevant products must be replaced. Designed lifetime (based on date of manufacture) in accordance with EN 13611, EN 1854 for DL..H, DL..N: 10 Jahre years.

You can find further explanations in the applicable rules and regulations and on the afecor website ([www.afecor.org](http://www.afecor.org)).

This procedure applies to heating systems. For thermoprocessing equipment, observe local regulations.

## 10 CERTIFICATION

### Declaration of conformity



We, the manufacturer, hereby declare that the products DL..H, DL..N with product ID No. CE- 0085AP0466 comply with the requirements of the listed Directives and Standards.

Directives:

- 2014/35/EU – LVD
- 2014/30/EU – EMC
- 2011/65/EU – RoHS II
- 2015/863/EU – RoHS III

Regulation:

- (EU) 2016/426 – GAR

Standards:

- EN 1854:2010

The relevant product corresponds to the tested type sample.

The production is subject to the surveillance procedure pursuant to Regulation (EU) 2016/426 Annex III paragraph 3.

Elster GmbH

Scan of the Declaration of conformity (D, GB) – see [www.docuthek.com](http://www.docuthek.com)

### 10.1 UL listed

USA and Canada



Underwriters Laboratories – UL 353 “Limit Controls”.

### 10.2 Eurasian Customs Union



The products DL..H, DL..N meet the technical specifications of the Eurasian Customs Union.

### 10.3 UKCA certified



Gas Appliances (Product Safety and Metrology etc. (Amendment etc.) (EU Exit) Regulations 2019)

BS EN 1854:2010

### 10.4 REACH Regulation

The device contains substances of very high concern which are listed in the Candidate List of the European REACH Regulation No. 1907/2006. See Reach list HTS at [www.docuthek.com](http://www.docuthek.com).

### 10.5 China RoHS

Directive on the restriction of the use of hazardous substances (RoHS) in China. Scan of the Disclosure Table China RoHS2, see certificates at [www.docuthek.com](http://www.docuthek.com).

## 11 LOGISTICS

### Transport

Protect the unit from external forces (blows, shocks, vibration).

Transport temperature: see page 6 (8 Technical data).

Transport is subject to the ambient conditions described.

Report any transport damage on the unit or packaging without delay.

Check that the delivery is complete.

### Storage

Storage temperature: see page 6 (8 Technical data).

Storage is subject to the ambient conditions described.

Storage time: 6 months in the original packaging before using for the first time. If stored for longer than this, the overall service life will be reduced by the corresponding amount of extra storage time.

## 12 DISPOSAL

Devices with electronic components:

### WEEE Directive 2012/19/EU – Waste Electrical and Electronic Equipment Directive



At the end of the product life (number of operating cycles reached), dispose of the packaging and product in a corresponding recycling centre. Do not dispose of the unit with the usual domestic refuse. Do not burn the product. On request, old units may be returned carriage paid to the manufacturer in accordance with the relevant waste legislation requirements.

## FOR MORE INFORMATION

The Honeywell Thermal Solutions family of products includes Honeywell Combustion Safety, Eclipse, Exothermics, Hauck, Kromschroder and Maxon. To learn more about our products, visit [ThermalSolutions.honeywell.com](http://ThermalSolutions.honeywell.com) or contact your Honeywell Sales Engineer.

Elster GmbH  
Strotheweg 1, D-49504 Lotte  
T +49 541 1214-0  
[hts.lotte@honeywell.com](mailto:hts.lotte@honeywell.com)  
[www.kromschroeder.com](http://www.kromschroeder.com)

Global centralized service deployment coordination:  
T +49 541 1214-365 or -555  
[hts.service.germany@honeywell.com](mailto:hts.service.germany@honeywell.com)

Translation from the German  
© 2022 Elster GmbH

**Honeywell**  
**kromschroder**